

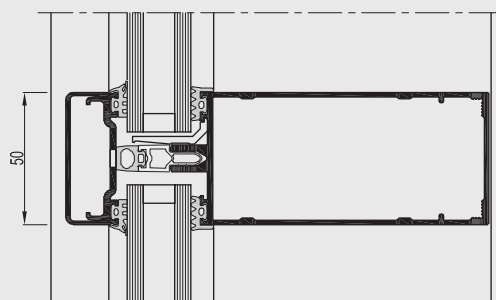

ConceptWall 50

Unlimited creative freedom and maximum entrance of light

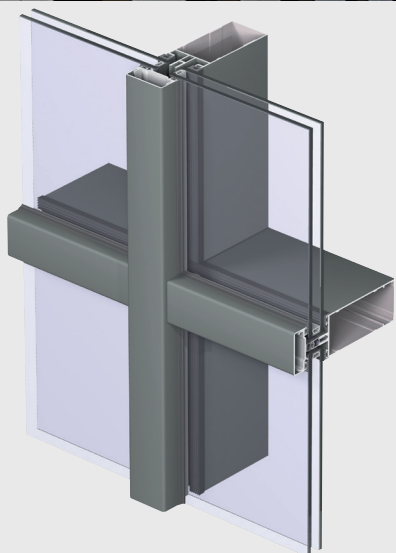

ConceptWall® 50 is a façade and roof system that offers unlimited design freedom and allows maximum transparency. As such, ConceptWall 50 meets all requirements of contemporary architecture. Innovative solutions contribute towards the tendency of big, heavy and thick glass panes. The system supports up to 700 kg in various glass support configurations. Even higher glass weight can be offered in bespoke solutions.

The system is available in several design and glazing variants, like steel beam look, standard pressure plates, structurally glazed and structurally clamped solutions. Specified levels of fire-resistance, burglar proof classes and thermal insulation, down to $U_f = 0.56W/m^2K$, are provided by different variants.

In addition to that, dedicated opening types can also be seamlessly integrated; a parallel opening window, a top hung window, a hidden vent turn and tilt window, but also an attic window for integration in roof applications of ConceptWall 50. Inward opening windows can be combined with the integrated vertical sun protection screens, a co-development with the specialists at Renson.

The ConceptWall 50 stands for an extensive range of profiles, gaskets, accessories and tools. It is specially developed for easy fabrication and installation.



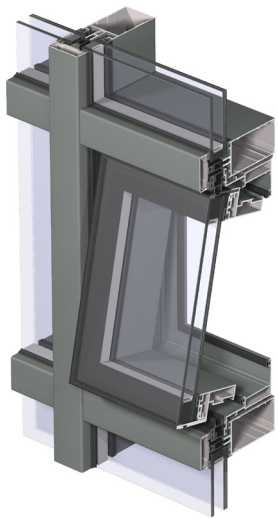

The extensive range of CW 50 profiles meets all requirements of contemporary architecture. With regard to the thermal performance, the system offers solutions in different levels, allowing the use of triple glazing and making the system even applicable for passive house or low energy buildings.

Opening elements with impressive performances and looks can be seamlessly integrated into the façade.

Available opening types:

Outward opening

The outward opening elements for CW have been completely redesigned. The elements are now better thermally insulated, capable of reaching the maximum dimensions in all variants, reach better performances overall, can be fitted with triple glass in both glazing bead and structural glazed variants, can be combined with all ConceptWall 50 variants and feature an improved production ease and speed.

They are available in 2 variants - **Top Hung or THW (1.)** and **Parallel Opening or POW (2.)** - both available with glazing bead, structural glazed and structural glazed stepped versions - can be motorized by chain drive. The reduced operating forces also allows a smooth manual operation with a large choice of handles. The opening can be restricted to suit local needs and regulations such as fall protection and Smoke & Heat Exhaust Ventilation Systems.

Although the THW is more commonly known and used and has its advantages (e.g. manually operated elements can be wider), the concept of a POW allows an ultimate airflow for small or tall windows. It can improve natural ventilation with the same window surface, which increases thermal comfort and a healthy indoor climate for building users. Aesthetically, a parallel way of opening gives a uniform impression: the reflection of the building remains the same for opened or closed sashes. A Parallel Opening Window allows an ultimate airflow for small or tall windows. This results in a better natural ventilation, improving the indoor air quality, thermal comfort and healthy indoor climate for building users.

1.

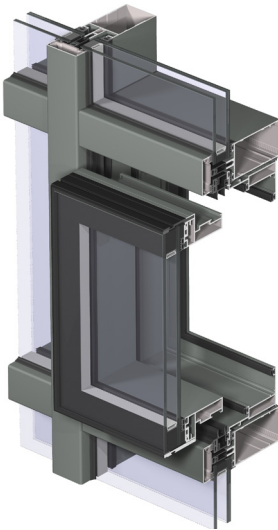

2.



Top Hung Window: THW



Parallel Opening Window: POW

The glass roof **Attic Window (3.)** variant has been fully reviewed to meet today's standards to provide a perfect water tight and high insulating solution for outward opening elements in inclined to nearly horizontal glass roofs. Different glazing options are available: either a cost efficient glazing bead version for standard glass, or a more aesthetic version with stepped glass. Both glass variants can be combined to create a zero water threshold on the bottom side to allow inclinations down to 5°.

The superior High Insulation variant assures an increased insulation by using additional gaskets and smart insulation strips including low-e foil. The possibility to integrate 62 mm glass in this HI version further enhances thermal efficiency.

A motor-operated version is especially convenient within building management systems or in roof windows in hard-to-reach places. The Attic window can be applied together with ConceptWall 50-RA, ConceptWall 60-RA and the ConceptRoof 120 conservatory system.

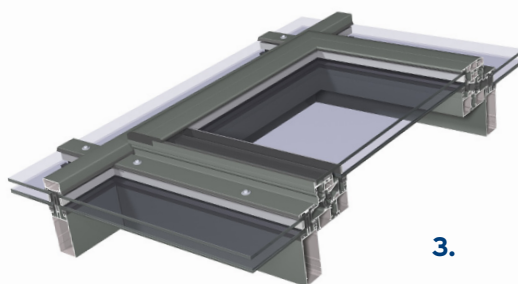

3.

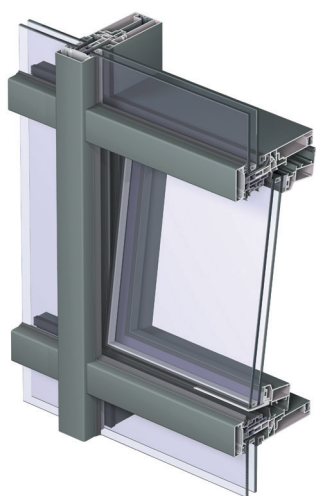

4.

Inward opening

A special type of Inward Opening Window, also known as the **Hidden Vent or HV (4.)**, is a structural sealed glazing solution which can be applied in a standard curtain wall façade or in a structurally clamped façade. It's main advantage it is indistinguishable from a fixed panel from the outside, therefore it doesn't affect the façade geometry. From the inside, this system uses a half mullion, resulting in a minimal visible width. Water tightness is assured by the use of a central gasket.

Integrated sun protection screens (co-development with Renson) are available in combination with the inward opening windows, as well as fixed façades.

Integration of Reynaers Aluminium window and door systems

Several aesthetical connection profiles allow a concealed integration of other Reynaers Aluminium window and door systems.

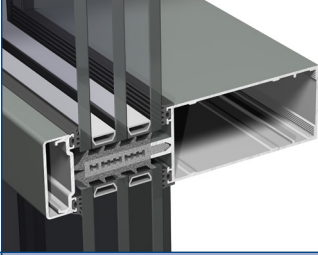
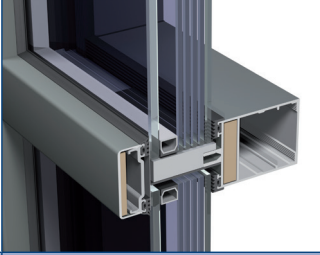

TECHNICAL CHARACTERISTICS

			
Style variants	CW 50	CW 50-HI	CW 50-FP
	functional	ultimate thermal comfort	Fire proof; E 15, EW 20, EI 15, E 30, EW 30, EI 30, E 60, EW 60 & EI 60
Interior visible width	50 mm	50 mm	50 mm
Exterior visible width	50 mm	50 mm	50 mm
Depth mullions	from 42 mm to 300 mm	from 42 mm to 300 mm	from 63 mm to 105 mm
Depth transoms	from 5 mm to 193 mm	from 5 mm to 193 mm	from 67 mm to 109 mm
Inertia mullions (lx: wind load)	min 14 cm ⁴ to max 2690 cm ⁴	min 14 cm ⁴ to max 2690 cm ⁴	min 38 cm ⁴ to max 123 cm ⁴
Inertia transoms (lx: wind load)	min 4 cm ⁴ to max 612 cm ⁴	min 4 cm ⁴ to max 612 cm ⁴	min 34 cm ⁴ to max 124 cm ⁴
Inertia transoms (ly: glass load)	min 8 cm ⁴ to max 59 cm ⁴	min 8 cm ⁴ to max 59 cm ⁴	min 20 cm ⁴ to max 29 cm ⁴
Exterior face caps	different shapes available	different shapes available	different shapes available
Glazing	fixing by pressure plates	fixing by pressure plates	fixing by pressure plates
Rebate height	20 mm	20 mm	20 mm
Glass thickness	from 6 mm to 61 mm	from 22 mm to 61 mm	35 mm / 45 mm to 48 mm
Opening types (see: description)*	1 - 2 - 3 - 4 - 5	1 - 2 - 3 - 4 - 5	CS 77-FP door
Roof application	yes	yes	no

TECHNICAL CHARACTERISTICS

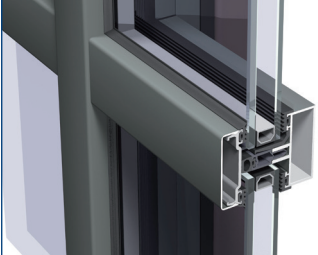
			
Style variants	CW 50-SL	CW 50 ALU ON STEEL	CW 50-TT
	slender appearance	designed for steel structure	rationalized system
Interior visible width	15/50 mm	50 mm	50 mm
Exterior visible width	50 mm	50 mm	50 mm
Depth mullions	from 126 mm to 168 mm	51 mm	-
Depth transoms	from 88 mm to 173 mm	from 5 mm to 58 mm	from 84 mm to 231 mm
Inertia mullions (lx: wind load)	min 160 cm ⁴ to max 381 cm ⁴	not applicable	-
Inertia transoms (lx: wind load)	min 73 cm ⁴ to max 436 cm ⁴	min 4 cm ⁴ to max 16 cm ⁴	min 74 cm ⁴ to max 937 cm ⁴
Inertia transoms (ly: glass load)	min 9 cm ⁴ to max 24 cm ⁴	min 8 cm ⁴ to max 13 cm ⁴	min 23 cm ⁴ to max 68 cm ⁴
Exterior face caps	different shapes available	different shapes available	different shapes available
Glazing	fixing by pressure plates / clamped	fixing by pressure plates / clamped	fixing by pressure plates / clamped
Rebate height	20 mm	20 mm	20 mm
Glass thickness	from 6 to 61 mm	from 6 to 61 mm	from 6 mm to 64 mm
Opening types (see description)*	1 - 2 - 3 - 4 - 5	1 - 2 - 3 - 4 - 5	1 - 2 - 5
Roof application	yes	yes	no

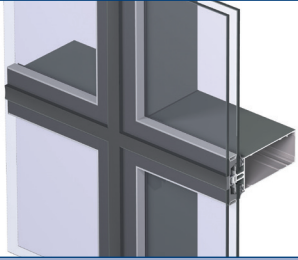
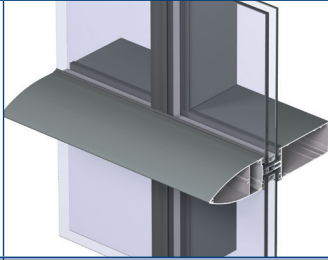
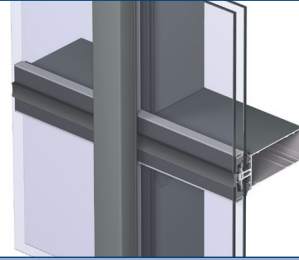
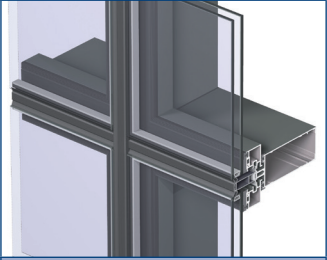

CW 50-HI is certified by the German notified body ift Rosenheim for passive house applications. This certification requires an overall insulation value of max. 0.7 W/m²K using glass with U_g 0.7 W/m²K and a panel with U_p of 0.25 W/m²K. With the CW 50-HI profiles, the curtain wall system achieved the overall insulation value of 0.66 W/m²K.

			
CW 50-SC	CW 50-HL	CW 50-VL	CW 50-SG
structural clamped glazing	aesthetical horizontal lining	aesthetical vertical lining	structural sealed glazing
50 mm	50 mm	50 mm	50/88 mm
joint: 20 mm	vertical: 20 mm joint horizontal: 50 mm	vertical: 50 mm horizontal: 20 mm joint	EPDM gasket (width 27 mm)
from 42 mm to 300 mm	from 42 mm to 300 mm	from 42 to 300 mm	from 42 mm to 300 mm
from 5 mm to 193 mm	from 5 mm to 193 mm	from 5 to 193 mm	from 5 mm to 193 mm
min 14 cm ⁴ to max 2690 cm ⁴	min 14 cm ⁴ to max 2690 cm ⁴	min 14 cm ⁴ to max 2690 cm ⁴	min 14 cm ⁴ to max 2690 cm ⁴
min 4 cm ⁴ to max 612 cm ⁴	min 4 cm ⁴ to max 612 cm ⁴	min 4 cm ⁴ to max 612 cm ⁴	min 4 cm ⁴ to max 612 cm ⁴
min 8 cm ⁴ to max 59 cm ⁴	min 8 cm ⁴ to max 59 cm ⁴	min 8 cm ⁴ to max 59 cm ⁴	min 8 cm ⁴ to max 59 cm ⁴
not applicable	different shapes available	different shapes available	not applicable
continuously clamped and locally clamped solution	vertical: continuously clamped and locally clamped solution horizontal: fixation by pressure plate	vertical: fixation by pressure plate horizontal: continuously clamped and locally clamped solution	structural glazing glued on cassettes
structural sealed glazing	20 mm /structural sealed glazing	20 mm/structural sealed glazing	structural sealed glazing
from 27 mm to 63 mm	from 22 mm to 48 mm	from 27 mm to 40 mm	from 24 mm to 36 mm
1 - 2 - 3 - 5	1 - 2 - 3 - 5	1 - 2 - 3 - 5	1 - 2 - 5
yes	no	yes	no





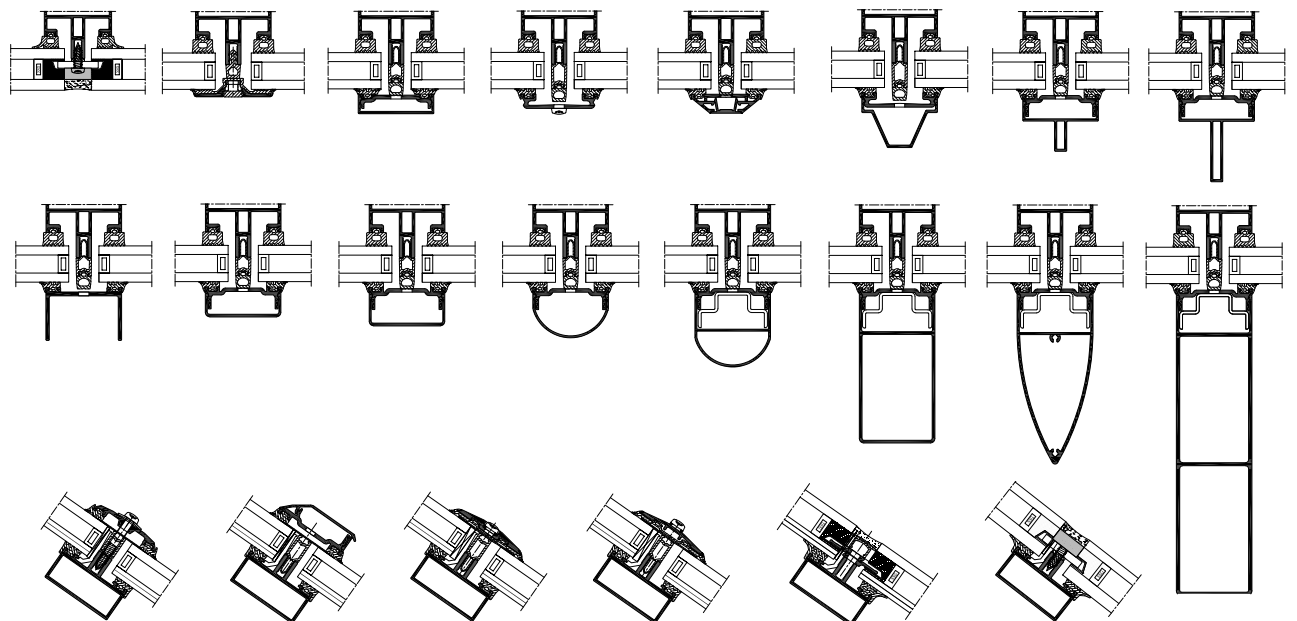





Overview exterior looks





REYNAERS
aluminium

TOGETHER FOR BETTER

PERFORMANCES							
ENERGY							
	Thermal insulation ⁽¹⁾ EN 12631:2012	Uf value down to 0,56 W/m ² K, depending on the profile combination					
COMFORT							
	Acoustic performance ⁽²⁾ EN ISO 10140-2; EN ISO 717-1	RW (C;Ctr) = 33 (-1; -4) dB / 60 (-2; -6) dB, depending on glazing or panel type					
	Air tightness ⁽³⁾ EN 12153, EN 12152	A1 (150 Pa)	A2 (300 Pa)	A3 (450 Pa)	A4 (600 Pa)	AE 1200 (1200 Pa)	AE 1950 (1950 Pa)
	Water tightness ⁽⁴⁾ EN 12155, EN 12154	R4 (150 Pa)	R5 (300 Pa)	R6 (450 Pa)	R7 (600 Pa)	RE 1200 (1200 Pa)	RE 1950 (1950 Pa)
	Wind load resistance, max. test pressure ⁽⁵⁾ EN 12179, EN 13116	2000 Pa			2400Pa		
	Resistance against impact EN 12600, EN 14019	I3 / E5			I5 / E5		
SAFETY							
	Fire Resistance ⁽⁶⁾ EN 1364-3, EN 13501-2	EI 15	EW 30	EI 30	E 60	EW 60	EI 60
	Burglar Resistance ⁽⁷⁾ EN 1627 - EN 1630	WK1 / RC1		WK2 / RC2		WK3 / RC3	

This table shows classes and values of performances, which can be achieved for specific configurations and opening types.

- (1) The Uf-value measures the heat flow. The lower the Uf-value, the better the thermal insulation of the curtain wall.
- (2) The sound reduction index (Rw) measures the capacity of the sound reduction performance of the curtain wall.
- (3) The air tightness test measures the volume of air that would pass through a curtain wall at a certain air pressure.
- (4) The water tightness testing involves applying a uniform water spray at increasing air pressure until water penetrates the curtain wall.
- (5) The wind load resistance is a measure of the profile's structural strength and is tested by applying increasing levels of air pressure to simulate the wind force.
- (6) The fire resistance is defined by exposing the curtain wall to direct fire in order to determine the stability, thermal insulation and radiation insulation over a certain amount of time.
- (7) The burglar resistance is tested by static and dynamic loads, as well as by stimulated attempts to break in using specific tools. This variant requires specific burglar resistance accessories and processing techniques.

